



# MRD-455-NA

Industrial Cellular Router



## General information

### Legal information

The contents of this document are provided “as is”. Except as required by applicable law, no warranties of any kind, either express or implied, including, but not limited to, the implied warranties of merchantability and fitness for a particular purpose, are made in relation to the accuracy and reliability or contents of this document. Westermo reserves the right to revise this document or withdraw it at any time without prior notice.

Under no circumstances shall Westermo be responsible for any loss of data or income or any special, incidental, and consequential or indirect damages howsoever caused.

More information about Westermo can be found at [www.westermo.com](http://www.westermo.com)

### Software tools

Related software tools are available at <https://www.westermo.com/support/product-support>

### License and copyright for included Free/Libre Open Source Software

This product includes software developed by third parties, including Free/Libre Open Source Software (FLOSS). The specific license terms and copyright associated with the software are included in each software package respectively. Please visit the product web page for more information.

Upon request, the applicable source code will be provided. A nominal fee may be charged to cover shipping and media. Please direct any source code request to your normal sales or support channel.





### Management Guide

This product runs MRX Operation System. Instructions for quick start, Configuration and factory reset are found in the Management Guide at [www.westermo.com](http://www.westermo.com).

## Safety and Regulations

Warning signs are provided to prevent personal injury and/or damages to the product.

The following levels are used:

Level of warning	Description	Consequence personal injury	Consequence material damage
 WARNING	Indicates a potentially hazardous situation	Possible death or major injury	Major damage to the product
 CAUTION	Indicates a potentially hazardous situation	Minor or moderate injury	Moderate damage to the product
 NOTICE	Provides information in order to avoid misuse of the product, confusion or misunderstanding	No personal injury	Minor damage to the product
 NOTE	Used for highlighting general, but important information	No personal injury	Minor damage to the product

## Before Installation

Read this manual completely and gather all information on the product. Make sure that you understand it fully. Check that your application does not exceed the safe operating specifications for this product.



### SAFETY DURING INSTALLATION

The product must be installed by qualified service personnel and built in to an apparatus cabinet or similar, where access is restricted to service personnel only.

Refer to Compliance Information to see the required level of qualified service personnel according to safety standards.

During installation, ensure a protective earthing conductor is first connected to the protective earthing terminal (only valid for metallic housings). Westermo recommends a cross-sectional area of at least 4 mm<sup>2</sup>.

Upon removal of the product, ensure that the protective earthing conductor is disconnected last.



### HAZARDOUS VOLTAGE

Do not open an energized product. Hazardous voltage may occur when connected to a power supply.



### PROTECTIVE FUSE

The power supply wiring must be sufficiently fused.

It must be possible to disconnect manually from the power supply. Ensure compliance to national installation regulations.



## **RADIO PRODUCTS**

Observe the usage limitations of radio products at filling stations, in chemical plants, in systems with explosives or potentially explosive locations.

The product may not be used in airplanes. Exercise particular caution near personal medical aids, such as pacemakers and hearing aids. Never perform work on the antenna system during a thunderstorm.

To fulfill human safety, a minimum separation distance of 20 cm or more should be maintained between the antenna of the product and personnel during operation.



## **ELECTROSTATIC DISCHARGE (ESD)**

Prevent electrostatic discharge damages to internal electronic parts by discharging your body to a grounding point (e.g. use a wrist strap).

## Care Recommendations

Follow the care recommendations below to maintain full operation of product and to fulfill the warranty obligations:

- Do not drop, knock or shake the product. Rough handling above the specification may cause damage to internal circuit boards.
- Use a dry or slightly water-damp cloth to clean the product. Do not use harsh chemicals, cleaning solvents or strong detergents.
- Do not paint the product. Paint can clog the product and prevent proper operation.

If the product is used in a manner not according to specification, the protection provided by the equipment may be impaired.

If the product is not working properly, contact the place of purchase, nearest Westermo distributor office or Westermo technical support.

## Product Disposal



This symbol means that the product shall not be treated as unsorted municipal waste when disposing of it. It needs to be handed over to an applicable collection point for recycling electrical and electronic equipment.

By ensuring this product is disposed of correctly, you will help to reduce hazardous substances and prevent potential negative consequences to both environment and human health, which could be caused by inappropriate disposal.

## Simplified EU declaration of conformity

Hereby, Westermo declares that the equipment is in compliance with applicable EU directives. The full EU declaration of conformity and other detailed information are available at the respective product page at [www.westermo.com](http://www.westermo.com).

## Agency approvals and standards compliance

Type		Approval/Compliance	
RED	Article 3.1a	EN 62368-1	Safety
		EN 562311	EMF exposure
	Article 3.1b	EN 301 489-1	ERM/EMC
		EN 301 489-7	ERM/EMC GSM
		EN 301 489-24	ERM/EMC 3G
	Article 3.2	EN 301 908-1	ERM 3G
		EN 301 908-2	ERM 3G
		EN 301 511	GSM
	Safety		IEC/EN 62368-1, Safety communication technology

## FCC Compliance MRD-455-NA variant

### Operating Requirements and Conditions:

The design of MRD-455-NA complies with U.S. Federal Communications Commission (FCC) guidelines respecting safety levels of radio frequency (RF) exposure for Mobile or Fixed devices.

### Caution Statement for Modifications:

CAUTION: Any changes or modifications not expressly approved by Westermo Network Technologies AB could void the user's authority to operate the equipment.

### FCC ID:

The MRD-455-NA contains FCCID: XPYTOBYL201

### Labelling:

A label must be affixed to the outside of the equipment with includes the following statement:

**Contains FCCID: XPYTOBYL201**

### FCC Part 15 Statement:

NOTE: This equipment has been tested and found to comply with the limits for a Class B digital device, pursuant to part 15 of the FCC Rules.

These limits are designed to provide reasonable protection against harmful interference in a residential installation. This equipment generates, uses and can radiate radio frequency energy and, if not installed and used in accordance with the instructions, may cause harmful interference to radio communications.

However, there is no guarantee that interference will not occur in a particular installation. If



this equipment does cause harmful interference to radio or television reception, which can be determined by turning the equipment off and on, the user is encouraged to try to correct the interference by one or more of the following measures:

- Reorient or relocate the receiving antenna.
- Increase the separation between the equipment and receiver.
- Connect the equipment into an outlet on a circuit different from that to which the receiver is connected.
- Consult the dealer or an experienced radio/TV technician for help.

This device complies with part 15 of the FCC Rules. Operation is subject to the following two conditions:

- This device may not cause harmful interference.
- This device must accept any interference received, including interference that may cause undesired operation. Any changes or modifications not expressly approved by the party responsible for compliance could void the user's authority to operate the equipment.

### **FCC RF Radiation Exposure Statement:**

This equipment complies with FCC RF radiation exposure limits set forth for an uncontrolled environment. This device and its antenna must not be co-located or operating in conjunction with any other antenna or transmitter.

*“To comply with FCC RF exposure compliance requirements, this grant is applicable to only **Fixed and Mobile Configurations**. The antennas used for this transmitter must be installed to provide a **separation distance of at least 20 cm** from all persons and must not be co-located or operating in conjunction with any other antenna or transmitter.”*

### **Conditions of Modular Grant:**

To meet the requirements of the modular grant for **u-blox TOBYL201 FCCID XPYTOBYL201** a maximum antenna gain is specified. The maximum antenna gain(s) for each operating frequency including cable loss for compliance with radiated power limits, RF exposure requirements and the categorical exclusion requirements of FCC 47 CFR 2.1091 is:

- 9.8 dBi for LTE FDD-17;
- 10.2 dBi for LTE FDD-13;
- 10.4 dBi for LTE FDD-5;
- 6.8 dBi for LTE FDD-4;
- 10.4 dBi for LTE FDD-2;
- 10.0 dBi for UMTS-5
- 8.5 dBi for UMTS-2.

### **Antenna Requirements:**

The MRD-455-NA is defined as a:

- Integrated Device without defined antenna
- Integrated Device with removable antenna, minimum antenna cable >20cm

Any antenna used must be have an antenna cable longer than 20cm.

A suitable external antenna is **Cybertec ITEM #5114 LTE+GPS+GLONASS 90mmx 30mm / 3m**

## Type tests and environmental conditions

Phenomena	Test	Description	Test levels
ESD	EN 61000-4-2	Enclosure, contact	± 6 kV
		Enclosure, air	± 8 kV
RF field AM modulated	IEC 61000-4-3	Enclosure	10 V/m (80 – 2700 MHz)
Fast transient	EN 61000-4-4	Signal ports	± 2 kV
		Power ports	± 2 kV
Surge	EN 61000-4-5	Signal ports	± 2 kV
		Power ports	± 2 kV
RF conducted	EN 61000-4-6	All ports	10 V/m (0.15 – 80 MHz)
Conducted magnetic Fields	EN 61000-4-8		10 A/m*
Radiated emission	CISPR 16-2-3 ANSI C63.4 (FCC part 15)	Enclosure	Class B
Conducted emission	CISPR 16-2-1 ANSI C63.4 (FCC part 15 b)	Power port	Class B
		Signal ports	Class B
<b>Environmental</b>			
Temperature	EN 60068-2-1 EN 60068-2-2	Operating	-40 to +70°C
		Storage & Transport	-40 to +85°C
Humidity	EN 60068-2-30	Operating	0 to 95% relative humidity non condensing.
		Storage & Transport	0 to 95% relative humidity non condensing.
Altitude		Operating	2000 m/70 kPa
Service life		Operating	10 year
MTBF	MIL-217-F		874 300 hours
Vibration	IEC 61373		
<b>Packaging</b>			
Enclosure			Aluminium
Dimension W x H x D			53 x 103 x 134 mm
Weight			0.40 kg
Degree of protection	EN 60529	Enclosure	IP40
Cooling			Convection
Mounting			Horizontal on 35 mm DIN-rail

## Description

Remote access removes boundaries, eliminates the need for time consuming site visits and provide a network infrastructure suitable for today's "always-on" society.

The MRD-455-NA industrial mobile broadband 3G/4G LTE router uses the Internet to cost effectively inter-connect systems, allowing HMI, PLCs, sensors etc to communicate with each other.

A compact design bundled with all interfaces and LEDs in the front make the unit extremely well suited for industrial applications. With isolation between the PSU and the Ethernet and serial ports the MRD-455-NA protects against issues caused by ground loops.

The dual SIM support in the device ensures that site connectivity is not dependent on a single carrier, should something happen the unit just switches to the other SIM.

Devices connected to the Internet require countermeasures towards cyber threats. The MRD-455-NA offers protection of transmissions from malicious eavesdroppers via encrypted communication tunnels (VPN), and features a simple, yet powerful, packet inspection firewall.

The MRD-455-NA with its built-in serial port offers a simple modem replacement solution with the benefit of not having to reprogram or change any other component.

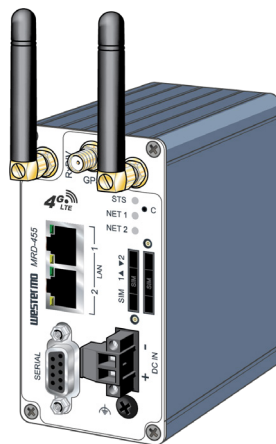

## Available Models

Art.no.	Description
3623-0601	MRD-455-NA Industrial Mobile Broadband Router (4G LTE) with dual SIM support for the North American market (AT&T and Verizon)

## Interface specifications

<b>Power</b>	
Rated voltage	12 – 48 VDC
Operating voltage	10 – 60 VDC
Rated frequency	DC
Start-up current (max)	400 mA
Polarity	Reverse polarity protected
Isolation to	All other
Connection	Detachable screw terminal
Shielded cable	Not required

<b>Ethernet TX</b>	
Electrical specification	IEEE std 802.3. 2005 Edition
Data rate	10 Mbit/s, 100 Mbit/s, manual or auto
Duplex	Full or half, manual or auto
Circuit type	SELV
Transmission range	100 m/328 ft
Isolation to	All other
Connection	RJ-45, auto MDI/MDIX
Shielded cable	Not required, except when installed in Railway applications as signalling and telecommunications apparatus and located close to rails.
Conductive housing	Yes
Number of ports	2

<b>RS-232</b>	
Electrical specification	EIA RS-232
Data rate	300 bit/s – 115.2 kbit/s
Data format	7 or 8 data bits, Odd, even or none parity, 1 or 2 stop bits
Protocol	Transparent, optimised by packing algorithm
Circuit type	SELV
Transmission range	15 m (49 ft)
Connection	9 pin D-sub female
Shielded cable	Not required
Conductive housing	Yes
Number of ports	1

<b>Cellular interface</b>	
Technology	Frequency band (MHz)
UMTS: HSDPA, HSUPA	B2 (1900), B5 (850)
LTE: FDD	B2 (1900), B4 (1700), B5 (850), B13 (700 upper), B17 (700 lower)
Category	LTE Cat.4

## Protocols and Functionality

Ethernet Technologies	IEEE 802.3 for 10BaseT IEEE 802.3u for 100BaseTX
Serial Port Technologies	RS-232 Serial Over IP (Serial Extender and Virtual Serial Port) Router emulation AT command interpreter MODBUS DNP3
Layer-2 QoS	IEEE 802.1p Class of Service
IP Routing, Firewall, VPN and Cyber Security	Static IP routing Dynamic IP routing <ul style="list-style-type: none"> <li>• RIPv1/v2</li> </ul> VRRP GRE Stateful inspection Firewall/ACL, NAT, Port Forwarding 25 x IPsec VPN, PSK & X.509* 1 x L2TP client 1 x PPTP client 1 x OpenVPN/SSL VPN client RADIUS PPP Dial in/Dial out
Manageability	Management tools <ul style="list-style-type: none"> <li>• Web interface (HTTP and HTTPS)</li> <li>• Command Line Interface (CLI) via SSHv2 and TELNET</li> <li>• SNMPv1/v2c/v3</li> <li>• SMS Control</li> </ul> Flexible alarm/event handling system Syslog (log files and remote syslog server) SNTP (NTP client) DHCP client DHCP server DDNS (Dynamic DNS update client)

\* 25 x Configurable IPsec VPNs, processing power in relation to traffic over VPN sets limitation on number of VPNs.

## Hardware Overview

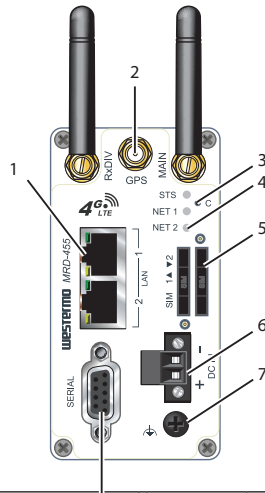

Position	Description	8	Position	Description
1	LED indicators		5	Power connector
2	Antenna Connectors		6	Serial Port
3	SIM-card drawer(s)		7	Ethernet TX ports
4	Protective Earth		8	Factory Reset Switch

## Connector Pinout

### Ethernet

The Ethernet ports are on the front of the unit and are marked LAN 1 and LAN 2, each port has a LED indicating the connection speed and a LED indicating activity as shown in figure below. Both ports are capable of auto-negotiation, meaning cross-over cables are not required. The Ethernet ports are switched, allowing more than one Ethernet device to be connected to the unit at one time

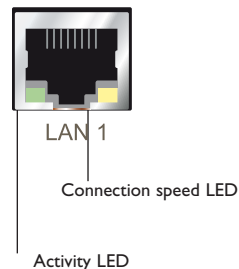

### Ethernet TX Connections (RJ-45 connector) LAN1-2

Position	Direction	Description
1	In/Out	TD+
2	In/Out	TD-
3	In/Out	RD+
4	-	Not Connected
5	-	Not Connected
6	In/Out	RD-
7	-	Not Connected
8	-	Not Connected

## DC connection

Position	Product marking	Direction	Description
1	-	Input	Common
2	+	Input	Supply voltage input DC

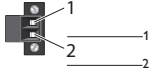

## Serial Port (DCE Female)

Position	Name	Direction	Description
1	DCD	Out	Data Carrier Detect
2	RxD	Out	Receive Data
3	TxD	In	Transmit Data
4	DTR	In	Data Terminal Ready
5	SG	-	Signal Ground
6	DSR	Out	Data Set Ready
7	RTS	IN	Request to Send
8	CTS	Out	Clear to Send
9	RI	Out	Ring Indicator



## LED Indicators

LED	Status	Description	
STS Status	RED	No wireless network has been detected	
	RED FLASH	A wireless network has been detected	
	GREEN	Power up self test OK/no issues	
NET NET 1 NET 2 Network indicator	OFF	Not ready	
	RED	RF circuitry initialising or network registration fault	
	GREEN/RED	Network connection fault	
	GREEN FLASH	Searching for network	
	GREEN	Locked to network	
	GREEN 1 BLINK	Signal strength indication	
	GREEN 2 BLINKS		
	GREEN 3 BLINKS		
	GREEN 4 BLINKS		1 Very poor
	GREEN 5 BLINKS		3 Normal
GREEN 6 BLINKS	6 Very good		



## Mounting

The MRD-455-NA should be mounted on 35 mm DIN-rail, which is horizontally mounted inside an apparatus cabinet or similar. Snap on mounting, see figure.

Mount the MRD-455-NA with integrated DIN-clip:

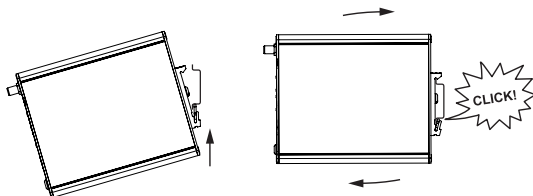

## Earth connection

For correct function, the ground connection on the unit needs to be properly connected to a solid ground. See figure.

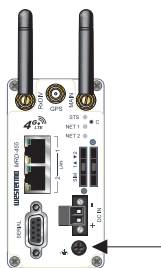

## Cooling

This unit uses convection cooling. Avoid obstructing the airflow around the unit. Spacing is recommended for the use of unit in full operating temperature range and service life.

The router should be mounted in a clean and dry location, protected from water, excessive dust, corrosive fumes, extremes of temperature and direct sunlight.

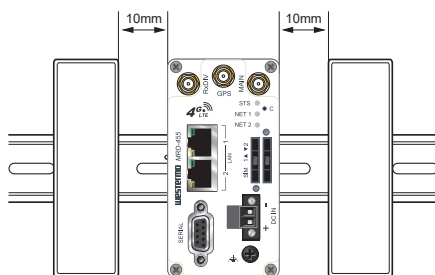



## Getting started

All configuration of the MRD can be done via the web interface. In order to view the web pages a computer with a fixed IP address, on the same sub-net as the MRD, will need to be connected to one of the LAN ports.

The default IP settings of the MRD are:

IP Address: 192.168.2.200

Netmask: 255.255.255.0

**Note:** The DHCP server of the unit is by default disabled.

### Accessing the MRD

- Open a web browser on the PC and browse to <http://192.168.2.200> (the default MRD, IP address) .
- A login box will popup. If the box fails to display, re-check the cable connections to the unit and the IP address settings of the PC.

Enter the following login details:

- User Name: admin
- Password: westermo
- The Status summary page will be displayed.

### Installing the SIM Card

- ⌘ To eject the SIM card drawer, press the SIM card eject button using a suitable tool and remove the drawer, refer to figure for the location of the SIM card eject button.
- ⌘ Insert the SIM card into the SIM card drawer with the contacts facing up, let chamfered corners align.
- ⌘ Slide the drawer back into the unit ensuring that it locks into place.

**Note:** Before removing or inserting the SIM card, ensure that the power has been turned off and the power connector has been removed from the MRD.

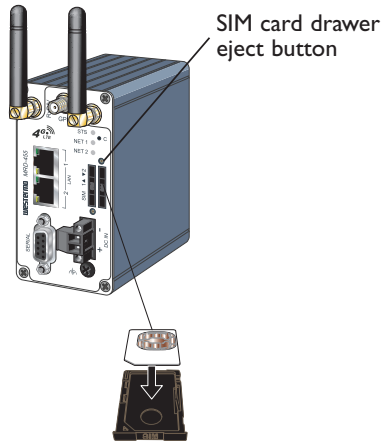

## Antenna(s)

The units have three antenna connectors (SMA). Please ensure that the connecting nut is done up tightly in order to make a good connection.

## Power Supply

The MRD requires a DC power source in the voltage range of 10 to 60 VDC. The unit is designed to self protect from permanent damage if the voltage exceeds 60 VDC or if reverse polarity is applied. The router may need to be returned for service if this occurs. The router can also be damaged if there is any potential difference between the chassis-ground, RS-232 signal ground, power (-) input, or antenna shield. Before connecting any wiring, ensure all components are earthed to a common ground point. An external isolator will be required if a positive earth power supply is used.

## Factory Default Reset Switch

The reset switch is used to restore the configuration of the MRD to factory default settings. The switch is accessed through a small hole on the rear of the unit adjacent to the power connector.

### To reset the configuration:

- Power down the unit.
- Use a suitable tool and depress the reset switch.
- Power up the unit ensuring the switch remains depressed for approximately 10 seconds after power is applied. The STS LED and NET LED will flash twice to indicate a reset.
- The router will now re-boot as normal with the factory default settings.

**Note:** Using the Factory Default Reset Switch will erase all existing configuration settings and restore the factory default settings. This includes the network connection profile settings APN, user name and password.

# Dimensions

Measurements are stated in millimeters.

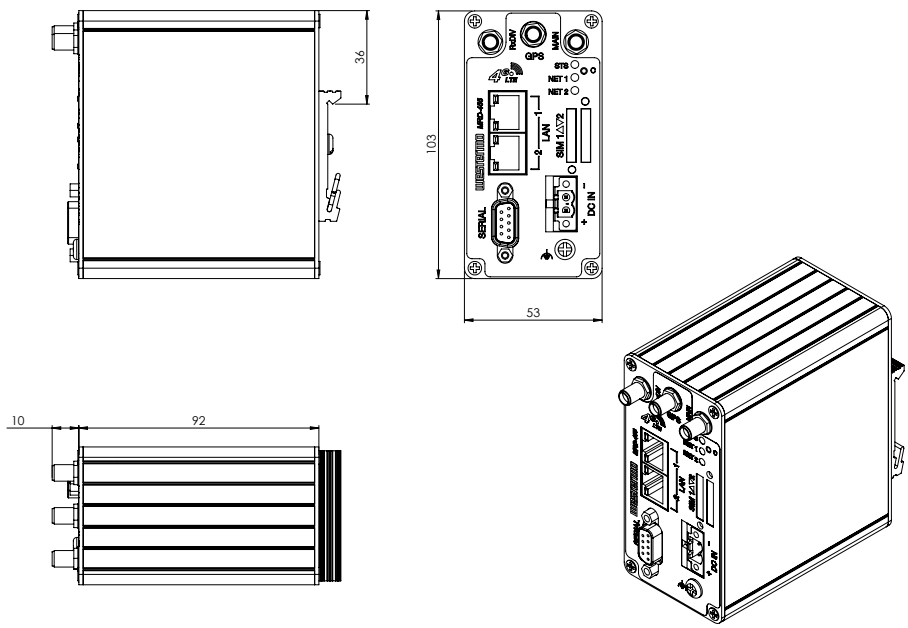

# WESTERMO

Westermo • Metallverksgatan 6, SE-721 30 Västerås, Sweden

Tel +46 16 42 80 00 Fax +46 16 42 80 01

E-mail: [info@westermo.com](mailto:info@westermo.com)

[www.westermo.com](http://www.westermo.com)